

Shaker Cylinders



ITT

ENGINEERED FOR LIFE

Shaker Series Features and Benefits

Shaker systems are pneumatically driven Feeder/Beltless Conveyor systems. These systems are ideal for the stamping industry or other parts transfer and scrap removal applications.

Compared to traditional conveyor systems, this "shaker" will save time and money!



**MODEL SHOWN:
SHK-25 WITH INTEGRAL VALVE**



**MODEL SHOWN:
SHK-12-R WITH REMOTE VALVE**

Use of Common Components

The use of standard Turn-Act cylinder components drastically reduces maintenance costs and down time.

A Model to Fit Any Application

Five base models to fit your specific die openings with all the power for a single tray or multiple tray applications.

Simplicity of Design

Fewer moving parts than competitive units means higher reliability and less maintenance.

Bolt It Up & It's Ready to Go

Simply mount to the die base and connect air.
No electrical connections needed.

All-Air Shifting

Eliminating mechanical shifting enhances dependability and extends cycle life.

Anodized Housing

Combines high strength mounting surface while protecting internal components.

Multi-Directional Speed Control

Independent controls allow adjustability in both forward and reverse directions.

Enersorb™ Piston

A patented piston design that provides smooth operation with non-lube service, high noise and energy absorption and an extended cycle life.

Specifications

- 5 base models
- 3/4 to 2 1/2 inch bores
- Tray loads to 50 pounds
- Maximum loads to 140 pounds
- Uses a shaking tray system that conveys finished parts, scrap or chips
- Lower cost than motorized conveyors
- Eliminate costly maintenance and replacement of belts and rollers
- Control valve can be integral or remote mounted

Air Pressure: 40-120 psi

Temperature: 32° - 180° F

Sound Level: 70 db

Recommended Speed: 60 cycles per minute

How to Order

Model #	Load Capacity	Max. Tray Weight	Shipping Weight	Stroke
SHK-12	50 LBS	15 LBS	17 LBS	4 IN
SHK-25	140 LBS	50 LBS	34 LBS	3 IN
SHK-07R	20 LBS	6 LBS	5 LBS	2 IN
SHK-12R	50 LBS	15 LBS	10 LBS	2 IN
SHK-25R	140 LBS	50 LBS	28 LBS	2 IN

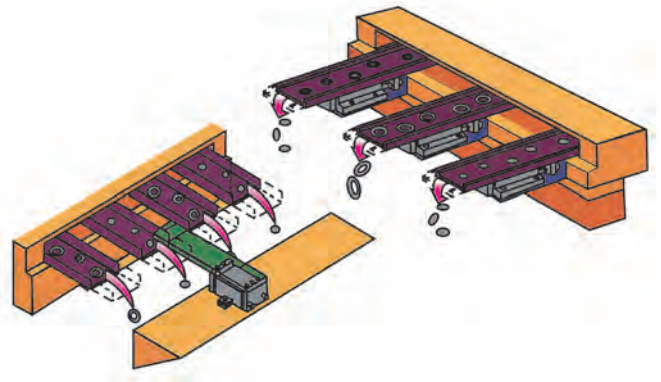

Engineering Data

Standard Shaker Integral Mount Valve

Dimensional Specifications		
	SHK-12	SHK-25
A	12.93	12.68
B	4.69	5.63
C	5.00	5.00
D	5.80	8.66
E	8.68	11.66
F	7.68	10.41
G	4.00	3.75
H	.41	.53
J	1.44	1.50
K	.94	1.03
L	3.06	3.10
M	.50	.63

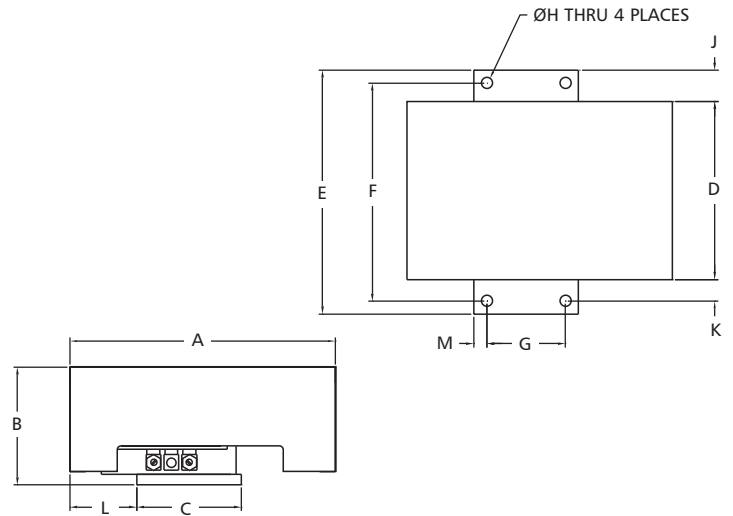

Low-Profile Shaker Remote Mount Valve

Dimensional Specifications			
	SHK-07R	SHK-12R	SHK-25R
A	5.50	7.00	9.00
B	4.88	6.25	8.00
C	3.50	5.00	6.88
D	.31	.38	.50
E	1.25	1.50	1.50
F	1.56	1.75	2.09
G	1.00	1.00	1.06
H	.41	.84	1.44
J	2.75	3.13	3.44
K	.69	.69	.63
L	#10-32	1/8 NPT	1/4 NPT
M	5/16	3/8	1/2
N	1.87	2.65	4.13
P	7.94	8.93	10.69
S	.38	.50	.75
T	7.56	*	9.94
U	.19	*	.38
V	1.03	*	2.00
W	1.23	*	2.44
X	#10-24	*	5/16-18

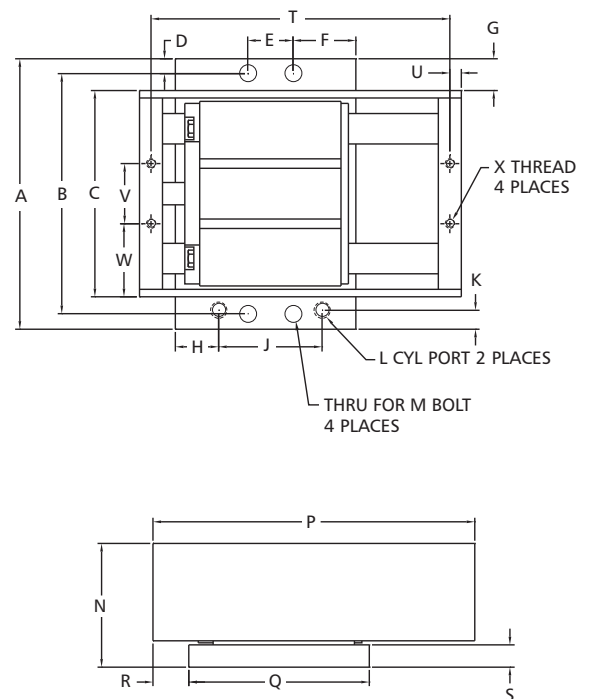

* 1-1/4 Bore has a top plate

Special Conditions and Limited Warranty

Determination of the suitability of any information or product for the application contemplated by any user or the manner of that use is the sole responsibility of the user.

Compact Automation Products, LLC reserves the right to improve or change designs without notice.

All orders are subject to acceptance by the factory sales department.

Compact Automation Products, LLC agrees to repair or replace to the original purchaser any standard parts or products for a period of 12 months from date of shipment which Compact Automation Products, LLC determines upon inspection to be defective in workmanship or material. Wear components including but not limited to seals and bearings are excluded from this warranty.

Under no circumstance may merchandise be returned without written authorization from the factory.

This warranty is void in the event the product has been tampered with, altered, or serviced by unauthorized personnel.

Compact Automation Products, LLC's total responsibility for any claims, damages, losses or liabilities related to the product covered thereunder shall not exceed the purchase price of such product. In no event shall Compact Automation Products, LLC be liable for any special, indirect, incidental or consequential damages of any character, including but not limited to loss of use of productive facilities or equipment, lost profit, property damage, transportation, installation or removal or lost production whether suffered by purchaser or third party. Compact Automation Products, LLC Inc. disclaims all liability for any and all cost, claims demands, charges, expenses, and other damages, either direct or indirect, incident to all property damage arising out of any cause of action based on strict liability. This warranty gives you specific legal rights and you may have other rights, which vary from state to state.



ENGINEERED FOR LIFE

Compact Automation Products
105 Commerce Way
Westminster, SC 29687
Tel: 864.647.9521
Fax: 864.647.9574
www.compactautomation.com
www.turn-act.com