

# Compact Universal Series®

## Product Catalogue



An **IMC** Company

Compact Automation Products®

105 Commerce Way  
Westminster, SC 29693

Phone: (864) 647-9521

Fax: (864) 647-9574

[www.compactautomation.com](http://www.compactautomation.com)

**Table of Contents**



Features and Benefits . . . . .Page 2

Engineering Specifications . . . . .Page 3

- Power Factor Table
- Enclosed Spring Forces
- Cylinder Weights

How to Order . . . . .Page 4

- Standard Stroke Length Availability

Double Acting Single Rod . . . . .Page 5

Double Acting Double Rod . . . . .Page 6

Mounting and Spring Options . . . . .Pages 7 & 8

Magnetic Piston, Urethane Cushion and Seal Options . . . .Page 9

Piston Rod Options . . . . .Page 10

Solid State Sensor Specifications . . . . .Page 11

Reed Sensor Specifications . . . . .Page 12

Application Data Worksheet . . . . .Page 13

Engineering Drawings CD-ROM . . . . .Inside Back Cover

## Features and Benefits

The new Compact Automation Products® Universal Series is a low-profile, extended family of pneumatic cylinder products that offers direct interchange for most square-bodied, pancake-type cylinders. In addition to providing unprecedented drop-in replacement capabilities, Universal Series cylinders offer exceptional performance under space constraints, with wide market appeal and countless custom options.

- Available in 4 basic models
- Bore sizes from 8 to 100mm
- Stroke sizes from 5 to 100mm (depending on model), in 5mm increments
- Standard metric ports and mounting
- Optional inch ports and mounting
- 100% Repairable

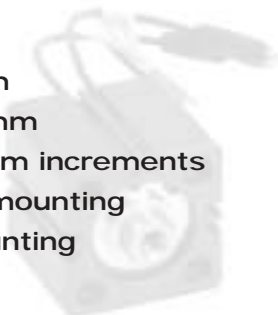

### Available Custom Options and Modifications:

- Heavy duty cylinders
- Hollow or oversized rod
- Adjustable stroke
- Custom rod ends
- Special frame and mounting
- Multiple stage cylinders
- Special bearings
- Special seals and lubricants
- Clean room option

	FEATURES	BENEFITS
<b>Frame</b>	<ul style="list-style-type: none"> <li>• Fully symmetrical shape</li> <li>• Rugged construction</li> <li>• Hard coat anodized aluminum body</li> <li>• Multiple mounting options</li> <li>• Integrated sensor groove</li> </ul>	<ul style="list-style-type: none"> <li>• Allows optional porting and mounting locations and increased flexibility for modifications</li> <li>• Service life durability and structural integrity</li> <li>• Excellent corrosion and wear resistance</li> <li>• Reduces mounting compromises</li> <li>• Flush mounted 4mm round – low profile "magneto-resistive" – accurate sensing</li> </ul>
<b>Piston</b>	<ul style="list-style-type: none"> <li>• High-strength aluminum alloy</li> </ul>	<ul style="list-style-type: none"> <li>• High yield strength for long life</li> </ul>
<b>Piston Rod</b>	<ul style="list-style-type: none"> <li>• Hard-chrome steel shaft</li> </ul>	<ul style="list-style-type: none"> <li>• Corrosion and wear resistance</li> </ul>
<b>Bearing Material</b>	<ul style="list-style-type: none"> <li>• Bronze</li> </ul>	<ul style="list-style-type: none"> <li>• Self-lubricating for long life and low breakaway friction</li> </ul>
<b>Piston Seal</b>	<ul style="list-style-type: none"> <li>• Buna-Nitrile low friction</li> </ul>	<ul style="list-style-type: none"> <li>• Low breakaway and long life</li> </ul>
<b>Rod Seal</b>	<ul style="list-style-type: none"> <li>• Buna-Nitrile low friction</li> </ul>	<ul style="list-style-type: none"> <li>• Low breakaway and long life</li> </ul>

*Special modifications available upon request. Consult Factory for details.*

**Engineering Specifications**

- Operating Medium: Compressed Air (Consult Factory for Hydraulic)
- Maximum Operating Pressure: 10 bar (140 psi)
- Ambient Operating Temperature: -10° to 70°C (15° to 160°F)
- Lubrication: Factory Pre-lubricated
- Standard Rod End: Female threaded (male on 8mm bore)
- Stroke Tolerance: ± .6mm (.025 inch)
- Standard Cylinder Mounting: Through hole with counter bores both ends

**POWER FACTOR TABLE**

Bore	8mm (5/16")		12mm (1/2")		16mm (5/8")		20mm (3/4")		25mm (1")		32mm (1-1/4")	
	Extend	Retract	Extend	Retract	Extend	Retract	Extend	Retract	Extend	Retract	Extend	Retract
Power Factor* (When input pressure in bar)	0.5	0.4	1.1	0.8	2.0	1.5	3.1	2.4	4.9	3.8	8.0	6.0
Power Factor** (When input pressure in psi)	(.077)	(.058)	(0.2)	(0.1)	(0.3)	(0.2)	(0.5)	(0.4)	(0.8)	(.6)	(1.2)	(0.9)

\*Power Factor x bar = kg  
\*\*Power Factor x psi = lbs.

Bore	40mm (1-1/2")		50mm (2")		63mm (2-1/2")		80mm (3-1/8")		100mm (4")	
	Extend	Retract	Extend	Retract	Extend	Retract	Extend	Retract	Extend	Retract
Power Factor* (When input pressure in bar)	12.6	10.6	19.6	16.5	31.2	28.0	50.3	45.4	78.5	71.5
Power Factor** (When input pressure in psi)	(1.9)	(1.6)	(3.0)	(2.6)	(4.8)	(4.3)	(7.8)	(7.0)	(12.2)	(11.1)

\*Power Factor x bar = kg  
\*\*Power Factor x psi = lbs.

**SPRING FORCES-EXTEND**

Action	Bore mm (in.)	Stroke mm	Relaxed Force lbs. (n)	Collapsed Force lbs. (n)	Spring Rate lbs./in. (n/mm)
SE	12 (1/2)	5	0.9 (4.0)	3.1 (13.7)	11.5 (2)
		10	0.9 (4.0)	2.9 (12.8)	5.0 (8.7)
	16 (5/8)	5	1.5 (6.6)	5.0 (22.2)	18.0 (3.14)
		10	1.6 (7.1)	5.3 (23.5)	9.7 (1.6)
	20 (3/4)	5	2.0 (8.8)	4.2 (18.6)	11.0 (1.9)
		10	2.0 (8.8)	7.6 (33.8)	14.0 (2.4)
	25 (1)	5	2.9 (12.8)	6.1 (27.1)	16.0 (2.7)
		10	4.9 (21.7)	11.2 (49.8)	14.0 (2.4)
	32 (1-1/4)	5	2.6 (11.5)	5.6 (24.9)	15.0 (2.6)
		10	3.6 (16.0)	7.5 (33.3)	10.0 (1.7)
	40 (1-1/2)	5	2.6 (11.5)	5.6 (24.9)	15.0 (.59)
			10	3.6 (16.0)	7.5 (33.0)
15		5.0 (22.2)	17.0 (75.6)	20.0 (3.4)	
		20	6.1 (27.0)	30.5 (135)	31.0 (5.4)
50 (2)	10	8.3 (36.9)	19.7 (87.6)	29.0 (5.0)	
		15	7.9 (35.0)	37.0 (164.5)	49.0 (8.5)
	20	9.0 (40.0)	30.2 (133)	27.0 (4.7)	
		10	2.0 (8.8)	16.7 (74.2)	37.0 (6.4)
63 (2-1/2)	15	7.9 (35.0)	37.0 (164.0)	49.0 (8.5)	
		20	9.0 (40.0)	30.2 (134.3)	27.0 (4.7)
	25	10.6 (47.0)	38.1 (169.0)	28.0 (4.8)	

Notes: All dimensions are in millimeters (inches).

**SPRING FORCES-RETRACT**

Action	Bore mm (in.)	Stroke mm	Relaxed Force lbs. (n)	Collapsed Force lbs. (n)	Spring Rate lbs./in. (n/mm)
SR	12 (1/2)	5	1.4 (6.2)	4.8 (21.3)	17.7 (3.0)
		10	1.6 (7.1)	6.4 (28.4)	12.0 (1.8)
	16 (5/8)	5	2.1 (9.3)	3.7 (16.4)	8.1 (1.4)
		10	1.0 (4.4)	4.9 (21.7)	10.0 (1.7)
	20 (3/4)	5	1.3 (5.7)	2.4 (10.6)	5.5 (.96)
		10	2.4 (10.6)	3.6 (16.0)	4.3 (.75)
	25 (1)	5	2.5 (11.1)	4.6 (20.4)	4.9 (.85)
		10	1.6 (7.1)	4.6 (20.4)	4.9 (.85)
	32 (1-1/4)	5	2.4 (10.6)	3.1 (13.7)	3.1 (.54)
		10	1.8 (8.0)	3.1 (13.7)	3.1 (.54)
	40 (1-1/2)	5	3.2(14.23)	5.2 (23.1)	10.0 (1.74)
		10	1.3 (5.7)	5.2 (23.1)	10.0 (1.74)
	50 (2)	10	10.1 (18.6)	18.0 (30.2)	20.0 (1.15)
			20	8.0 (9.7)	25.3 (33.8)
		20	8.0 (9.7)	25.3 (33.8)	22.0 (1.04)
	63 (2-1/2)	25	8.0 (9.7)	25.3 (33.8)	22.0 (1.04)

Notes: All dimensions are in millimeters (inches).

## How to Order

Product Family	
Code	Description
UV	Universal Series

Series	
Code	Description
S	Square Body, End Mounts

Bore	
Code	Description
8	8mm (5/16)
12	12mm (1/2)
16	16mm (5/8)
20	20mm (3/4)
25	25mm (1)
32	32mm (1-1/4)
40	40mm (1-1/2)
50	50mm (2)
63	63mm (2-1/2)
80	80mm (3-1/8)
100	100mm (4)

Piston Seal Options	
Code	Description
V	Viton - High Temp Seal (Max 400°F)

Cushion Options	
Code	Description
UC1	Urethane Cushions, Rod End
UC2	Urethane Cushion, Rear End
UC3	Urethane Cushion, Both Ends

Thread Options	
Code	Description
U	U.S. Customary Units (Inches)

**STANDARD PART NUMBER**      **OPTIONS**

UV S DS 8 X 15 — U RC V — EX5 UC1

Model	
Code	Description
DS	Double Acting, Single Rod End
DSA	Magnetic Double Acting, Single-Rod End
DD	Double Acting, Double-Rod End
DDA	Magnetic Double Acting, Double-Rod End
SE	Single-Acting, Spring Extend
SEA	Magnetic Single Acting, Spring Extend
SR	Single-Acting, Spring Retract
SRA	Magnetic Single Acting, Spring Retract

Stroke
5-100mm See table below (1mm increments available by special request)

Mounting Options	
Code	Description
RC	Rear mounting clevis, pin right angle to the port axis
RCV	Rear mounting clevis, pin parallel to axis of port
RE	Rod Eye on single rod end
REF	Rod Eye on front end of double rod
RER	Rod Eye on rear of double rod
RED	Rod Eye on both ends of double rod
TE	Threaded Both Ends
TS	Threaded Side mount on side 3

Rod Options	
Code	Description
MS	Male Stud on single rod
MSF	Male Stud on front end of double rod
MSR	Male Stud on rear end of double rod
MSD	Male Stud on both ends of double rod
BE	Blank Rod End
EX_*	Rod Extension
EXD_*	Rod Extension on double rod, equal extensions on both ends
EXF_*	Rod Extensions Front
EXR_*	Rod Extensions Rear
HR0	Hollow Rod Blank
HR1	Hollow Rod Threaded
HR3	Hollow Rod Pipe Threads

Standard Cylinder Configuration	
Features	Description
Ports	Port Position 1
Threads	Metric
Mounting	Thru-Hole No Threads
Seals	Buna-Nitrile Seal
Rod	Female Threads (8mm rod is male threaded)
Cushions	No Urethane Cushions

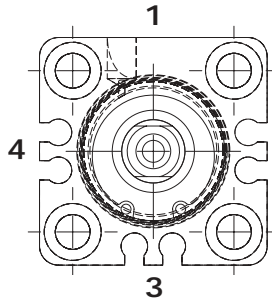

Note: Use drawing for position reference

\*Specify total length of rod (See page 8 for reference)

### CYLINDER WEIGHTS

Bore Size mm (in.)	Approximate Cylinder Weight		Weight Added (per 5mm Stroke)	
	g	(lbs.)	g	(lbs.)
8 (5/16)	14.9	(.03)	3.5	(.01)
12 (1/2)	28.4	(.06)	5.8	(.01)
16 (5/8)	43.9	(.10)	8.3	(.02)
20 (3/4)	53.9	(.12)	11.8	(.03)
25 (1)	80.6	(.18)	14.9	(.03)
32 (1-1/4)	120.8	(.27)	21.0	(.05)
40 (1-1/2)	190.0	(.42)	21.6	(.05)
50 (2)	301.5	(.66)	33.8	(.07)
63 (2-1/2)	492.0	(1.08)	41.0	(.09)
80 (3-1/8)	892.7	(1.96)	62.8	(.14)
100 (4)	1,892.9	(4.16)	110.4	(.24)

### STANDARD STROKE LENGTH AVAILABILITY

Bore Size mm (in.)	Double Acting		Single Acting	
	Single Rod End mm	Double Rod End mm	Spring Extend mm	Spring Retract mm
8 (5/16)				
12 (1/2)	5, 10, 15, 20, 25, 30	5, 10, 15, 20, 25, 30	5, 10	5, 10
16 (5/8)				
20 (3/4)	5, 10, 15, 20, 25, 30	5, 10, 15, 20, 25, 30	5, 10	5, 10
25 (1)	35, 40, 45, 50	35, 40, 45, 50		
32 (1-1/4)	5, 10, 15, 20, 25, 30	5, 10, 15, 20, 25, 30	5, 10	
40 (1-1/2)	35, 40, 45, 50, 75, 100	35, 40, 45, 50	5, 10, 15, 20	5, 10
50 (2)			10, 15, 20	10, 20
63 (2-1/2)	10, 15, 20, 25, 30, 35	10, 15, 20, 25, 30,	10, 15, 20, 25	20, 25
80 (3-1/8)	40, 45, 50, 75, 100	35, 40, 45, 50	Consult Factory	Consult Factory
100 (4)			Consult Factory	Consult Factory

Notes: All dimensions are in millimeters (inches). Please specify "U" option when ordering using inches.

**Double Acting/Single Rod (DS)**

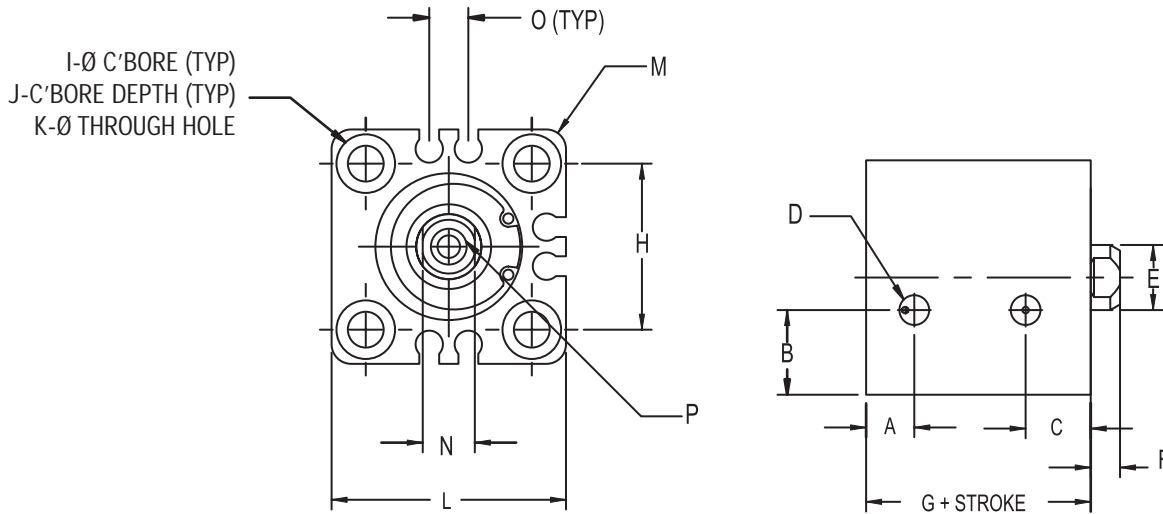

Note: Port positions only available on one side

**DOUBLE ACTING/SINGLE ROD (DS)**

Bore Size mm (in.)	A	B	C	D	E	F*	G	H
8 (5/16)	5.3 (.20)	10.5 (.41)	5.3 (.20)	M5X.8 (#10-32)	4.0 (.16)	7.5 (.29)	13.5 (.53)	13.0 (.51)
12 (1/2)	6.5 (.25)	9.5 (.37)	7.5 (.29)	M5X.8 (#10-32)	6.0 (.23)	3.5 (.14)	17.0 (.66)	15.5 (.60)
16 (5/8)	6.5 (.25)	10.0 (.39)	9.4 (.37)	M5X.8 (#10-32)	8.0 (.31)	3.5 (.14)	18.5 (.72)	20.0 (.78)
20 (3/4)	7.4 (.29)	13.0 (.51)	10.0 (.39)	M5X.8 (#10-32)	10.0 (.39)	4.5 (.18)	19.5 (.76)	25.5 (.99)
25 (1)	7.8 (.30)	15.0 (.59)	11.0 (.43)	M5X.8 (#10-32)	12.0 (.47)	5.0 (.20)	22.5 (.88)	28.0 (1.09)
32 (1-1/4)	9.5 (.37)	17.0 (.66)	12.0 (.47)	G -1/8 (NPT - 1/8)	16.0 (.62)	7.0 (.27)	23.0 (.90)	34.0 (1.33)
40 (1-1/2)	11.0 (.43)	18.0 (.70)	11.0 (.43)	G -1/8 (NPT - 1/8)	16.0 (.62)	7.0 (.27)	29.5 (1.15)	40.0 (1.56)
50 (2)	12.5 (.49)	21.5 (.84)	15.0 (.59)	G -1/4 (NPT - 1/4)	20.0 (.78)	8.0 (.31)	30.5 (1.19)	50.0 (1.95)
63 (2-1/2)	13.0 (.51)	25.0 (.98)	15.7 (.61)	G -1/4 (NPT - 1/4)	20.0 (.78)	8.0 (.31)	36.0 (1.40)	60.0 (2.34)
80 (3-1/8)	11.7 (.46)	32.0 (1.25)	17.8 (.69)	G -3/8 (NPT - 3/8)	25.0 (.98)	10.0 (.39)	43.5 (1.70)	77.0 (3.00)
100 (4)	12.2 (.48)	32.0 (1.25)	24.4 (.95)	G -3/8 (NPT - 3/8)	30.0 (1.17)	12.0 (.47)	53.0 (2.07)	94.0 (3.67)

Notes: All dimensions are in millimeters (inches).  
Please specify "U" option when ordering using inches (see page 4 for reference).

Bore Size mm (in.)	I	J	K	L	M	N	O	P
8 (5/16)	5.7 (.22)	3.5 (.14)	3.5 (.14)	21.0 (.82)	3.0 (.12)	7.5 (.29)	N/A	M3X.5 6H (#8-32 UNC-2B)*
12 (1/2)	6.1 (.24)	3.5 (.14)	3.5 (.14)	25.0 (.98)	3.0 (.12)	5.0 (.20)	5.4 (.21)	M3X.5 6H (#8-32 UNC-2B)
16 (5/8)	6.5 (.25)	3.5 (.14)	3.5 (.14)	29.0 (1.13)	3.0 (.12)	6.0 (.23)	6.0 (.24)	M4X.7 6H (#8-32 UNC-2B)
20 (3/4)	9.0 (.35)	7.0 (.27)	5.5 (.21)	36.0 (1.40)	3.0 (.12)	8.0 (.31)	6.0 (.24)	M5X.8 6H (#10-32 UNF-2B)
25 (1)	9.0 (.35)	7.0 (.27)	5.5 (.21)	40.0 (1.56)	3.0 (.12)	10.0 (.39)	6.0 (.24)	M6X1.0 6H (1/4-28 UNF-2B)
32 (1-1/4)	9.0 (.35)	7.0 (.27)	5.5 (.21)	49.5 (1.93)	3.0 (.12)	14.0 (.55)	6.0 (.24)	M8X1.25 6H (5/16-24 UNF-2B)
40 (1-1/2)	9.0 (.35)	7.0 (.27)	5.5 (.21)	57.0 (2.22)	3.0 (.12)	14.0 (.55)	6.0 (.24)	M8X1.25 6H (3/8-24 UNF-2B)
50 (2)	11.1 (.43)	8.0 (.31)	6.9 (.27)	71.0 (2.77)	3.0 (.12)	17.0 (.66)	6.0 (.24)	M10X1.5 6H (1/2-20 UNF-2B)
63 (2-1/2)	14.1 (.55)	10.5 (.41)	8.8 (.34)	84.0 (3.28)	6.0 (.23)	17.0 (.66)	6.0 (.24)	M10X1.5 6H (1/2-20 UNF-2B)
80 (3-1/8)	17.5 (.68)	13.5 (.53)	11.0 (.43)	104.0 (4.06)	6.0 (.23)	22.0 (.86)	8.0 (.31)	M16X2.0 6H (5/8-18 UNF-2B)
100 (4)	17.5 (.68)	13.5 (.53)	11.0 (.43)	123.5 (4.82)	6.0 (.23)	27.0 (1.05)	8.0 (.31)	M20X2.5 6H (3/4-16 UNF-2B)

\*8mm rod is male threaded.

Notes: All dimensions are in millimeters (inches).  
Please specify "U" option when ordering using inches (see page 4 for reference).

**Double Acting/Double Rod (DD)**

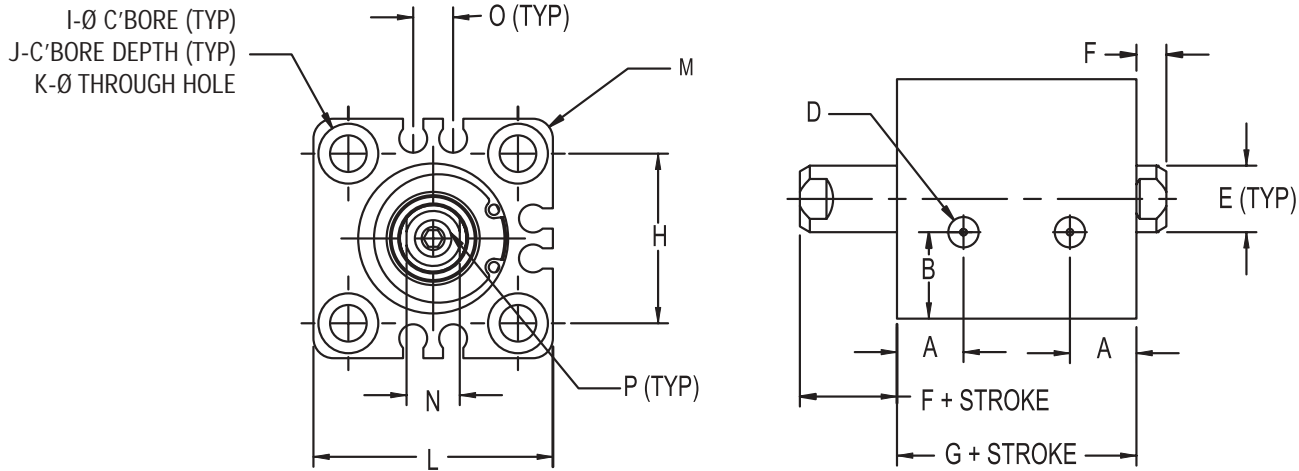

Note: Minimum thread depth is same as male thread (see page 8, RR Option).

**DOUBLE ACTING/DOUBLE ROD (DD)**

Bore Size mm (in.)	A	B	D	E	F*	G	H	I
8 (5/16)	5.3 (.20)	10.5 (.41)	M5X.8 (#10-32)	4.0 (.16)	7.5 (.29)	13.5 (.53)	13.0 (.51)	5.7 (.22)
12 (1/2)	8.5 (.33)	9.5 (.37)	M5X.8 (#10-32)	6.0 (.23)	3.5 (.14)	25.2 (.98)	15.5 (.60)	6.1 (.24)
16 (5/8)	9.4 (.37)	10.0 (.39)	M5X.8 (#10-32)	8.0 (.31)	3.5 (.14)	26.0 (1.01)	20.0 (.78)	6.5 (.25)
20 (3/4)	10.0 (.39)	13.0 (.51)	M5X.8 (#10-32)	10.0 (.39)	4.5 (.18)	26.0 (1.01)	25.5 (.99)	9.0 (.35)
25 (1)	11.0 (.43)	15.0 (.59)	M5X.8 (#10-32)	12.0 (.47)	5.0 (.20)	29.0 (1.13)	28.0 (1.09)	9.0 (.35)
32 (1-1/4)	11.5 (.45)	17.0 (.66)	G -1/8 (NPT - 1/8)	16.0 (.62)	7.0 (.27)	30.5 (1.19)	34.0 (1.33)	9.0 (.35)
40 (1-1/2)	13.1 (.51)	18.0 (.70)	G -1/8 (NPT - 1/8)	16.0 (.62)	7.0 (.27)	40.0 (1.56)	40.0 (1.56)	9.0 (.35)
50 (2)	15.0 (.59)	21.5 (.84)	G -1/4 (NPT - 1/4)	20.0 (.78)	8.0 (.31)	40.5 (1.58)	50.0 (1.95)	11.1 (.43)
63 (2-1/2)	12.8 (.50)	25.0 (.98)	G -1/4 (NPT - 1/4)	20.0 (.78)	8.0 (.31)	42.0 (1.64)	60.0 (2.34)	14.1 (.55)
80 (3-1/8)	14.4 (.56)	32.0 (1.25)	G -3/8 (NPT - 3/8)	25.0 (.98)	10.0 (.39)	51.0 (1.99)	77.0 (3.00)	17.5 (.68)
100 (4)	18.3 (.71)	32.0 (1.25)	G -3/8 (NPT - 3/8)	30.0 (1.17)	12.0 (.47)	60.5 (2.36)	94.0 (3.67)	17.5 (.68)

Notes: All dimensions are in millimeters (inches).  
Please specify "U" option when ordering using inches (see page 4 for reference).

Bore Size mm (in.)	J	K	L	M	N	O	P
8 (5/16)	3.5 (.14)	3.5 (.14)	21.0 (.82)	3.0 (.12)	3.5 (.14)	N/A	M3X.5 6H (#8-32 UNC-2B)*
12 (1/2)	3.5 (.14)	3.5 (.14)	25.0 (.98)	3.0 (.12)	5.0 (.20)	5.4 (.21)	M3X.5 6H (#8-32 UNC-2B)
16 (5/8)	3.5 (.14)	3.5 (.14)	29.0 (1.13)	3.0 (.12)	6.0 (.23)	6.0 (.24)	M4X.7 6H (#8-32 UNC-2B)
20 (3/4)	7.0 (.27)	5.5 (.22)	36.0 (1.40)	3.0 (.12)	8.0 (.31)	6.0 (.24)	M5X.8 6H (#10-32 UNF-2B)
25 (1)	7.0 (.27)	5.5 (.22)	40.0 (1.56)	3.0 (.12)	10.0 (.39)	6.0 (.24)	M6X1.0 6H (1/4-28 UNF -2B)
32 (1-1/4)	7.0 (.27)	5.5 (.22)	49.5 (1.93)	3.0 (.12)	14.0 (.55)	6.0 (.24)	M8X1.25 6H (5/16-24 UNF -2B)
40 (1-1/2)	7.0 (.27)	5.5 (.22)	57.0 (2.22)	3.0 (.12)	14.0 (.55)	6.0 (.24)	M8X1.25 6H (3/8-24 UNF -2B)
50 (2)	8.0 (.31)	6.9 (.27)	71.0 (2.77)	3.0 (.12)	17.0 (.66)	6.0 (.24)	M10X1.5 6H (1/2-20 UNF -2B)
63 (2-1/2)	10.5 (.41)	8.8 (.35)	84.0 (3.28)	6.0 (.24)	17.0 (.66)	6.0 (.24)	M10X1.5 6H (1/2-20 UNF -2B)
80 (3-1/8)	13.5 (.53)	11.0 (.43)	104.0 (4.06)	6.0 (.24)	22.0 (.86)	8.0 (.31)	M16X2.0 6H (5/8-18 UNF -2B)
100 (4)	13.5 (.53)	11.0 (.43)	123.5 (4.82)	6.0 (.24)	27.0 (1.05)	8.0 (.31)	M20X2.5 6H (3/4-16 UNF -2B)

\*8mm rod is male threaded.

Notes: All dimensions are in millimeters (inches).  
Please specify "U" option when ordering using inches (see page 4 for reference).

**Spring Extend (SE)**

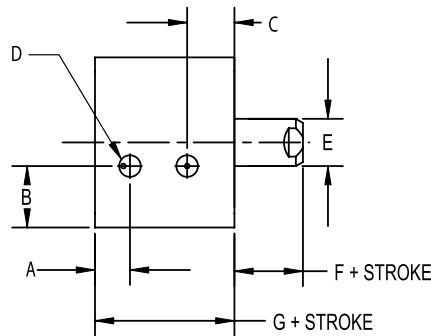

**Spring Retract (SR)**

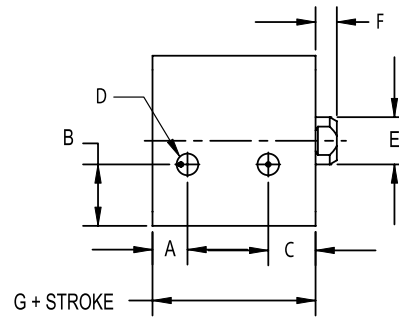

Note: Ports shown on Side 4 (Side 1 is standard position)

**SPRING EXTEND (SE)/SPRING RETRACT (SR)**

Bore Size mm (in.)	A	B	C	D	E	F	G
12 (1/2)	6.5 (.25)	9.5 (.37)	7.5 (.29)	M5X.8 (#10-32)	6.0 (.24)	3.5 (.14)	17.0 (.66)
16 (5/8)	6.5 (.25)	10.0 (.39)	9.4 (.37)	M5X.8 (#10-32)	8.0 (.31)	3.5 (.14)	18.5 (.72)
20 (3/4)	7.4 (.29)	13.0 (.51)	10.0 (.39)	M5X.8 (#10-32)	10.0 (.39)	4.5 (.18)	19.5 (.76)
25 (1)	7.8 (.30)	15.0 (.59)	11.0 (.43)	M5X.8 (#10-32)	12.0 (.47)	5.0 (.20)	22.5 (.88)
32 (1-1/4)	9.5 (.37)	17.0 (.66)	12.0 (.47)	G -1/8 (NPT - 1/8)	16.0 (.62)	7.0 (.27)	23.0 (.90)
40 (1-1/2)	11.0 (.43)	18.0 (.70)	11.0 (.43)	G -1/8 (NPT - 1/8)	16.0 (.62)	7.0 (.27)	29.5 (1.15)
50 (2)	12.5 (.49)	21.5 (.84)	15.0 (.59)	G -1/4 (NPT - 1/4)	20.0 (.78)	8.0 (.31)	30.5 (1.19)
63 (2-1/2)	13.0 (.51)	25.0 (.98)	15.7 (.61)	G -1/4 (NPT - 1/4)	20.0 (.78)	8.0 (.31)	36.0 (1.40)

Notes: All dimensions are in millimeters (inches).  
Please specify "U" option when ordering using inches (see page 4 for reference).

**THREADED BOTH ENDS (TE)**

Bore Size mm (in.)	W	X	Y
12 (1/2)	M4X0.7 (#8-32 UNC-2B)	10.5 (.41)	7.0 (.28)
16 (5/8)	M4X0.7 (#8-32 UNC-2B)	10.5 (.41)	7.0 (.28)
20 (3/4)	M6X1.0 (1/4-20 UNC-2B)	17.0 (.67)	10.0 (.39)
25 (1)	M6X1.0 (1/4-20 UNC-2B)	17.0 (.67)	10.0 (.39)
32 (1-1/4)	M6X1.0 (1/4-20 UNC-2B)	17.0 (.67)	10.0 (.39)
40 (1-1/2)	M6X1.0 (1/4-20 UNC-2B)	17.0 (.67)	10.0 (.39)
50 (2)	M8X1.25 (5/16-18 UNC-2B)	22.0 (.87)	14.0 (.55)
63 (2-1/2)	M10X1.5 (7/16-14 UNC-2B)	28.0 (1.12)	18.0 (.71)
80 (3-1/8)	M12X1.75 (1/2-13 UNC-2B)	35.6 (1.40)	22.0 (.87)
100 (4)	M12X1.75 (1/2-13 UNC-2B)	35.6 (1.40)	22.0 (.87)

Notes: All dimensions are in millimeters (inches).  
Please specify "U" option when ordering using inches (see page 4 for reference).

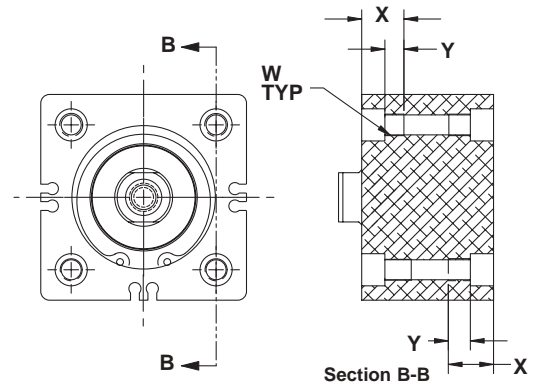

**THREADED SIDE MOUNT (TS\_)**

Bore Size mm (in.)	H	U	T
12 (1/2)	15.5 (.61)	M4X0.7 6H (#8-32 UNC-2B)	6.6 (.26)
16 (5/8)	20.0 (.79)	M4X0.7 6H (#8-32 UNC-2B)	6.6 (.26)
20 (3/4)	25.5 (1.00)	M6X1.0 6H (1/4-20 UNC-2B)	11.2 (.44)
25 (1)	28.0 (1.10)	M6X1.0 6H (1/4-20 UNC-2B)	11.2 (.44)
32 (1-1/4)	34.0 (1.34)	M6X1.0 6H (1/4-20 UNC-2B)	11.2 (.44)
40 (1-1/2)	40.0 (1.57)	M6X1.0 6H (1/4-20 UNC-2B)	11.2 (.44)
50 (2)	50.0 (1.97)	M8X1.25 6H (5/16-18 UNC-2B)	13.0 (.51)
63 (2-1/2)	60.0 (2.36)	M10X1.5 6H (7/16-14 UNC-2B)	16.8 (.66)
80 (3-1/8)	77.0 (3.03)	M12X1.75 6H (1/2-13 UNC-2B)	20.8 (.82)
100 (4)	94.0 (3.70)	M12X1.75 6H (1/2-13 UNC-2B)	20.8 (.82)

Notes: All dimensions are in millimeters (inches).  
Only two mounting holes on smaller stroke cylinders.  
Please specify "U" option when ordering using inches (see page 4 for reference).

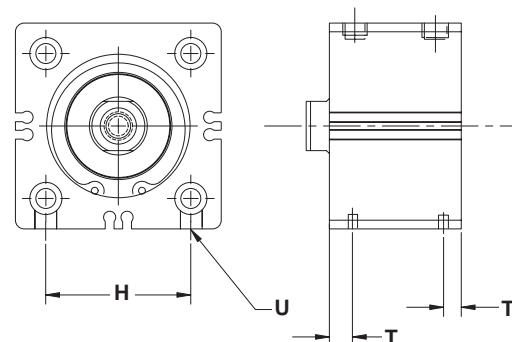



## REAR MOUNTING CLEVIS (RC, RCV)

Bore Size mm (in.)	A	B	C
12 (1/2)	20.0 (0.79)	14.0 (0.55)	7.0 (0.28)
16 (5/8)	21.0 (0.83)	15.0 (0.59)	10.0 (0.39)
20 (3/4)	27.0 (1.06)	18.0 (0.71)	9.0 (0.35)
25 (1)	30.0 (1.18)	20.0 (0.79)	14.0 (0.55)
32 (1-1/4)	30.0 (1.18)	20.0 (0.79)	14.0 (0.55)
40 (1-1/2)	32.0 (1.26)	22.0 (0.87)	14.0 (0.55)
50 (2)	42.0 (1.65)	28.0 (1.10)	20.0 (0.79)
63 (2-1/2)	44.0 (1.73)	30.0 (1.18)	20.0 (0.79)
80 (3-1/8)	56.0 (2.21)	38.0 (1.50)	27.0 (1.06)
100 (4)	67.0 (2.64)	45.0 (1.77)	31.0 (1.22)

Notes: All dimensions are in millimeters (inches).  
Please specify "U" option when ordering  
using inches (see page 4 for reference).

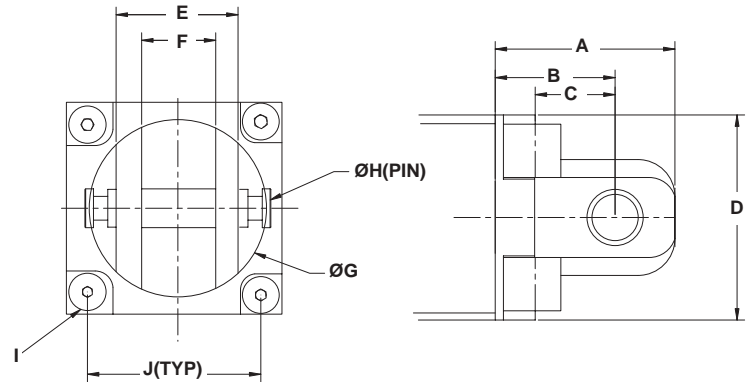

Bore Size mm (in.)	D	E	F	G	H	I	J
12 (1/2)	25.0 (0.98)	10.0 (0.39)	5.0 (0.21)	13.0 (0.51)	5.0 (0.197)	M4X0.7(#8-32 UNC)	15.5 (0.61)
16 (5/8)	29.0 (1.14)	12.0 (0.47)	7.0 (0.27)	15.0 (0.58)	5.0 (0.197)	M4X0.7(#8-32 UNC)	20.0 (0.79)
20 (3/4)	36.0 (1.41)	16.0 (0.62)	8.0 (0.33)	21.0 (0.82)	8.0 (0.315)	M6X1.0(1/4-20 UNC)	25.5 (1.00)
25 (1)	40.0 (1.57)	20.0 (0.78)	10.0 (0.41)	22.0 (0.85)	10.0 (0.394)	M6X1.0(1/4-20 UNC)	28.0 (1.10)
32 (1-1/4)	45.0 (1.77)	36.0 (1.41)	18.0 (0.72)	39.0 (1.53)	10.0 (0.394)	M6X1.0(1/4-20 UNC)	34.0 (1.34)
40 (1-1/2)	52.0 (2.04)	36.0 (1.41)	18.0 (0.72)	39.0 (1.53)	10.0 (0.394)	M6X1.0(1/4-20 UNC)	40.0 (1.58)
50 (2)	64.0 (2.52)	44.0 (1.72)	22.0 (0.87)	49.0 (1.91)	14.0 (0.551)	M8X1.25(5/16-18 UNC)	50.0 (1.97)
63 (2-1/2)	77.0 (3.03)	44.0 (1.72)	22.0 (0.87)	49.0 (1.91)	14.0 (0.551)	M10X1.5(7/16-14 UNC)	60.0 (2.36)
80 (3-1/8)	98.0 (3.85)	56.0 (2.20)	28.0 (1.11)	62.0 (2.44)	18.0 (0.709)	M12X1.75(1/2-13 UNC)	77.0 (3.03)
100 (4)	117.0 (4.60)	64.0 (2.20)	32.0 (1.27)	72.0 (2.84)	22.0 (0.866)	M12X1.75(1/2-13 UNC)	94.0 (3.70)

Notes: All dimensions are in millimeters (inches).  
Please specify "U" option when ordering  
using inches (see page 4 for reference).

## MALE STUD (MS, MSF, MSR, MSD)

Bore Size	METRIC			U OPTION		
	SS	RR	F	RR	F	SS
12 (1/2)	M3X0.5	10.5 (0.41)	14.0 (0.55)	10.5 (0.41)	15.0 (0.55)	#8-32 UNC
16 (5/8)	M4X0.7	12.0 (0.55)	15.5 (0.73)	12.0 (0.55)	15.5 (0.73)	#8-32 UNC
20 (3/4)	M5X0.8	14.0 (0.55)	18.5 (0.73)	14.0 (0.55)	18.5 (0.73)	#10-32 UNC
25 (1)	M6X1.0	17.5 (0.69)	22.5 (0.89)	17.5 (0.69)	22.5 (0.89)	#1/4-28 UNF
32 (1-1/4)	M8X1.25	23.5 (0.93)	30.5 (1.20)	23.5 (0.93)	30.5 (1.20)	#5/16-24 UNF
40 (1-1/2)	M8X1.25	23.5 (0.93)	30.5 (1.20)	23.5 (0.93)	30.5 (1.20)	#3/8-24 UNF
50 (2)	M10X1.5	28.5 (1.12)	36.5 (1.44)	28.5 (1.12)	36.5 (1.44)	#1/2-20 UNF
63 (2-1/2)	M10X1.5	28.5 (1.12)	36.5 (1.44)	28.5 (1.12)	36.5 (1.44)	#1/2-20 UNF
80 (3-1/8)	M16X2.0	35.5 (1.40)	45.5 (1.79)	35.5 (1.40)	45.5 (1.79)	#5/8-18 UNF
100 (4)	M20X2.5	35.5 (1.40)	47.5 (1.87)	35.5 (1.40)	47.5 (1.87)	#3/4-16 UNF

\*8mm rod is male threaded.

Notes: All dimensions are in millimeters (inches).  
Please specify "U" option when ordering  
using inches (see page 4 for reference).

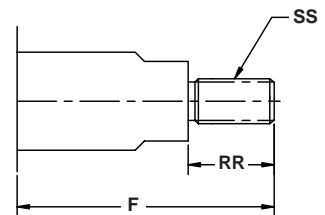

## ROD EXTENSION (EX\_, EXD\_, EXF\_, EXR\_)

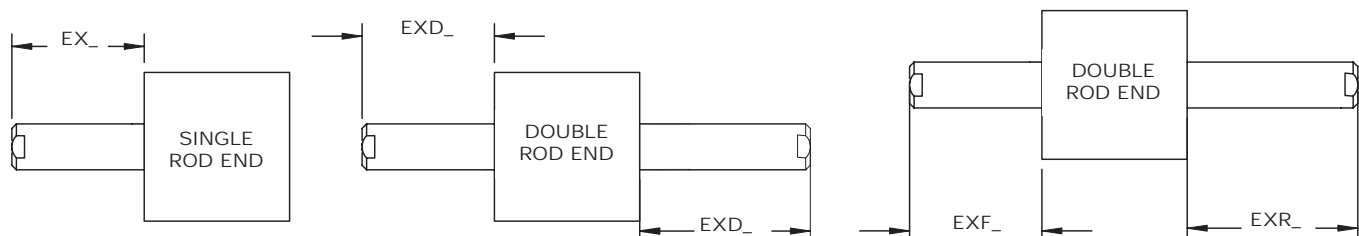

Notes: All rod extensions are measured in the retracted position.

**MAGNETIC PISTON**

Bore Size mm (in.)	G	
	Single Rod	Double Rod
8 (5/16)	23.5 (.92)	23.5 (.92)
12 (1/2)	27.0 (1.05)	32.4 (1.26)
16 (5/8)	28.5 (1.11)	36.0 (1.40)
20 (3/4)	29.5 (1.15)	36.0 (1.40)
25 (1)	32.5 (1.27)	39.0 (1.52)
32 (1-1/4)	33.0 (1.29)	40.5 (1.58)
40 (1-1/2)	39.5 (1.54)	50.0 (1.95)
50 (2)	40.5 (1.58)	50.5 (1.97)
63 (2-1/2)	46.0 (1.79)	52.0 (2.03)
80 (3-1/8)	53.5 (2.09)	61.0 (2.38)
100 (4)	63.0 (2.46)	70.5 (2.75)

Notes: All dimensions are in millimeters (inches).  
 Please specify "U" option when ordering  
 using inches (see page 4 for reference).

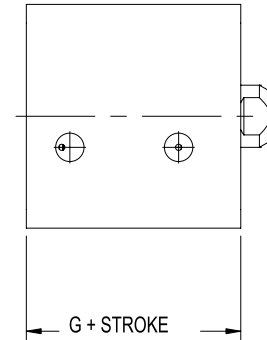

**URETHANE CUSHIONS (UC1, UC2, UC3)**

(Stroke reduction by model for all bores.)

MODEL	STROKE REDUCTION	
	mm	inches
Double Acting Single Rod End	3.0	0.12
Double Acting Double Rod End		
Single Acting Spring Retract	1.5	0.06
Single Acting Spring Extend		

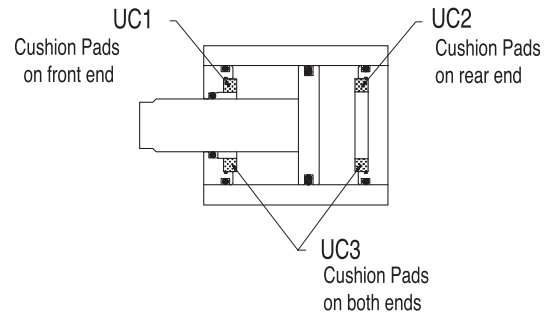

**SEALS**

<b>Buna-Nitrile</b>	8-100mm	Standard	-18° to 93°C 0° to 200°F	Most commonly used elastomer o-ring due to its excellent compatibility to petroleum products and resistance to wear, tear and friction. Works with lubricated or non-lubricated air in the noted temperature range. Recommended for general purpose sealing with petroleum oils and fluids, water, silicone greases and oils.
<b>Viton-Fluorocarbon</b>	12-100mm	V	-18° to 204°C 0° to 400°F	Used mainly for elevated temperatures, harsh environments where some coolants, solvents, cleaning agents or other chemicals will contact the seal gland. Lower compression set is characteristic. For your specific requirements, consult factory.

Rod Eye (RE, REF, RER, RED)

Small Bore (for 12mm to 63mm)

Large Bore (80mm & 100mm)

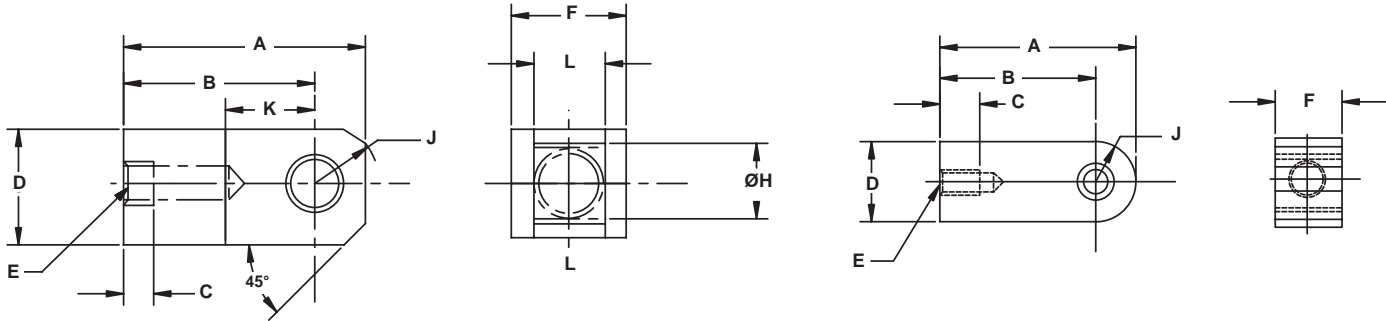

ROD EYE (RE, REF, RER, RED)

Bore Size mm (in.)	A	B	C	D	E	F	H	J	K	L
8 (5/16)	N/A	N/A	N/A	N/A	N/A	N/A	N/A	N/A	N/A	N/A
12 (1/2)	21.5 (0.85)	16 (0.63)	6.0 (0.24)	10 (0.39)	M5X0.8 (#8-32 UNC)	4.7 (0.19)	5 (0.190)	6.3 (0.25)	6.9	4.7
16 (5/8)	32.0 (1.25)	25 (0.99)	8.0 (0.99)	12 (0.47)	M6X1.0 (#8-32 UNC)	12 (0.25)	5 (0.190)	7.9 (0.31)	13.9	6.2
20 (3/4)	34.0 (1.34)	25 (0.99)	8.5 (0.99)	16 (0.63)	M8X1.25 (#10-32 UNF)	16 (0.31)	8 (0.314)	10.3 (0.41)	11.4	7.7
25 (1)	41.0 (1.62)	30 (1.19)	10.5 (1.19)	20 (0.79)	M10X1.25 (1/4-28 UNF)	20 (0.38)	10 (0.377)	12.7 (0.50)	13.9	9.7
32 (1-1/4)	40.5 (1.60)	30 (1.19)	14 (1.19)	22 (0.87)	M14X1.5 (5/16-24 UNF)	22 (0.70)	10 (0.377)	12 (0.47)	13.9	17.6
40 (1-1/2)	40.5 (1.60)	30 (1.19)	14 (1.19)	22 (0.87)	M14X1.5 (3/8-24 UNF)	22 (0.70)	10 (0.377)	12 (0.47)	13.9	17.6
50 (2)	53.8 (2.12)	40 (1.58)	18 (1.58)	28 (1.10)	M18X1.5 (1/2-20 UNF)	28 (0.85)	14 (0.501)	16 (0.63)	19.9	21.6
63 (2-1/2)	53.8 (2.12)	40 (1.58)	18 (1.58)	28 (1.10)	M18X1.5 (1/2-20 UNF)	28 (0.85)	14 (0.501)	16 (0.63)	19.9	21.6
80 (3-1/8)	70.2 (2.77)	50 (1.97)	21 (1.97)	38 (1.50)	M22X1.5 (5/8-18 UNF)	27.6 (1.09)	18.04 (0.753)	21 (0.83)	N/A	N/A
100 (4)	77.9 (3.07)	55 (2.17)	21 (2.17)	44 (1.73)	M26X1.5 (3/4-16 UNF)	31.6 (1.25)	22.04 (0.878)	24 (0.94)	N/A	N/A

Notes: All dimensions are in millimeters (inches).  
Please specify "U" option when ordering  
using inches (see page 4 for reference).

Hollow Rod (HR0, HR1, HR3)

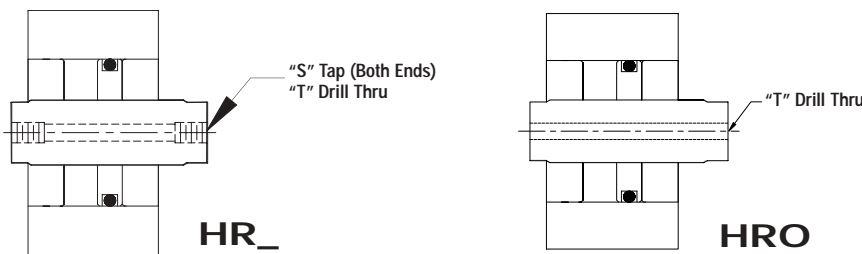

HOLLOW ROD (HR0, HR1, HR3)

Bore Size mm (in.)	Rod Diameter	HR1		HR3		HRO
		"S" TAP	"T" Drill Thru	"S" TAP	"T" Drill Thru	"T" Drill Thru
8 (5/16)	N/A	N/A	N/A	N/A	N/A	N/A
12 (1/2)	N/A	N/A	N/A	N/A	N/A	N/A
16 (5/8)	8	M5X0.8X12.5DP	4.3	N/A	N/A	4.3*
20 (3/4)	10	M5X0.8X12.5DP	4.3	N/A	N/A	4.3*
25 (1)	12	M6X1X15DP	5.2	G-1/8	8.5	8.5*
32 (1-1/4)	16	M6X1X15DP	5.2	G-1/8	8.5	8.5*
40 (1-1/2)	16	M6X1X15DP	5.2	G-1/8	8.5	8.5*
50 (2)	20	CONSULT FACTORY				14.6*
63 (2-1/2)	20					14.6*
80 (3-1/8)	25					20.6*
100 (4)	30					20.6*

Notes: All dimensions are in millimeters (inches).  
Please specify "U" option when ordering  
using inches (see page 4 for reference).



(shown with Quick Disconnect Option)

- Low cost and compact size
- Single LED indicator for signal
- Circuit protection (surge and polarity)
- High-flex robotic grade cable with 4.8mm (3/16") bend radius.
- CE compliant / IP67 and NEMA 6P rated

Part No.	Sensor Type	Cord Type		Lead	
		Quick Disconnect	1m	3m	
WSKLRPS	NPN (sinking)	✓			
WSKLR	NPN (sinking)		✓		
WSKLR-3	NPN (sinking)			✓	
WSCLRPS	PNP (sourcing)	✓			
WSCLR	PNP (sourcing)		✓		
WSCLR-3	PNP (sourcing)			✓	
WRS	REED		✓		
WRS-3	REED			✓	

Notes: PS denotes 150mm lead  
-3 denotes 3m flying lead

### Dimensional Information

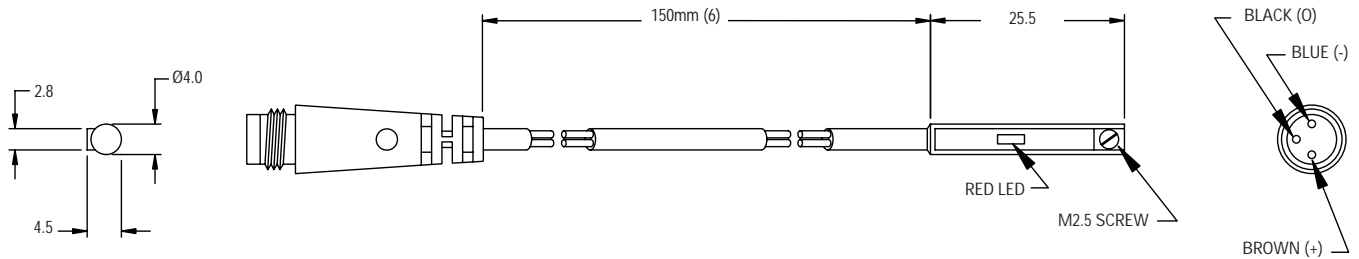

Notes: All dimensions are in millimeters (inches).  
WS\_LR, WS\_LR-3 have flying leads.

### SOLID STATE SENSOR SPECIFICATIONS

Parameters	Compact <sup>®</sup> Round Limit Sensors	
	NPN (sinking)	PNP (sourcing)
Part Number	WSKLR	WSCLR
Operating Voltage	5 - 24 VDC	
Current Consumption	7mA (24V) max	9mA (24V) max
Switching Current	50 mA max	
Voltage Drop	.5 V max @ 25mA	1.2 V max @ 25 mA
Operating Frequency	1 KHz max	
Switch Logic	Sinking <i>Normally Open</i>	Sourcing <i>Normally Open</i>
LED Function	RED (Switch Active)	
Operating Temperature	-20° to 70°C	

Parameters	Compact <sup>®</sup> Round Limit Sensors	
	NPN (sinking)	PNP (sourcing)
Part Number	WSKLR	WSCLR
Circuit Protection	Reverse Polarity/Surge Suppression	
Environmental Certifications	IP67, NEMA 6P	
Wire Type	Black Polyurethane Jacket, PVC Insulation	
Housing Material	Plastic	
Housing Color Code	Black	
Shock Resistance	50G max	
Vibration Strength	9G max	

**\*WARNING:** Never Exceed Rating (Watts = Voltage x Amps) Power Rating\*: 1.5 watts

## WIRING DIAGRAMS AND DEFINITIONS *for units with flying leads*

### NPN Output Sinking (K)

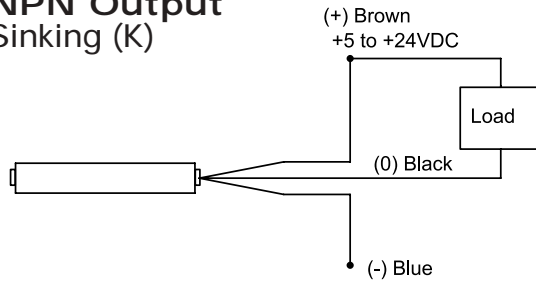

- Ideal for complex controls utilizing multiple power supplies.

A “sinking” output sensor completes a circuit by connecting the load to ground. Sinking output sensors in a sequence can have different supply voltages. The ground is their common factor.

### PNP Output Sourcing (C)

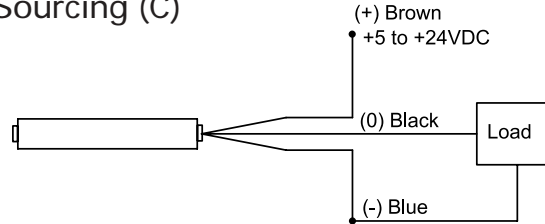

- Ideal for single power supply applications.

A “sourcing” output sensor completes a circuit by connecting the load to the supply current. All sourcing output sensors must have the same supply voltage.

## REED SENSOR SPECIFICATIONS

Parameters	Compact® Round Limit Sensors
	Reed Switch
Part Number	WRS
Operating Voltage	5-120 V DC/AC 50/60 Hz
Switching Current	50mA max
Voltage Drop	2.5 V max
Operating Frequency	1 KHz max
Switch Logic	SPST Normally Open
LED Function	Red
Circuit Protection	None
Environmental Certifications	IP67, NEMA 6P
Cable	Black/Gray
Magnet Requirement	50 Gauss Parallel
Temperature Range	14 to 158°F (-10 to +70° C)
Shock/Vibration	30G/9G
Power Rating*	6 Watts

## Circuit and Connect Diagram

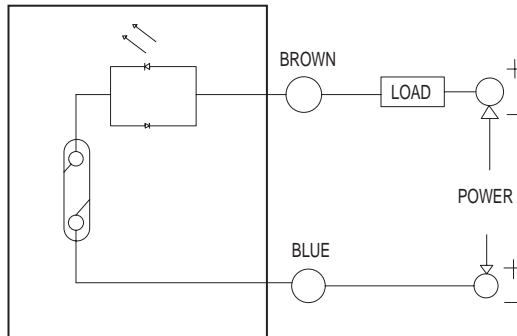

**\*WARNING:** Never Exceed Rating (Watts = Voltage x Amps)  
Permanent damage to sensor will occur.

**APPLICATION DATA SHEET** (To be attached to RFQ Sheet)

CUSTOMER: _____ PHONE: _____	CONTACT: _____ FAX: _____	INDUSTRY: _____ E-MAIL: _____
DISTRIBUTOR: _____ PHONE: _____	CONTACT: _____ FAX: _____	E-MAIL: _____
BASIC CYLINDER TO BE MODIFIED: _____ or bore size _____ (in. or mm) X stroke _____ (in. or mm)		

**Application Specifications**

Actuating fluid:  Air;  Hydraulic oil;  Other (please specify): \_\_\_\_\_  
 Operating pressure range: \_\_\_\_\_ to \_\_\_\_\_ (psi or bar - min. to max.) or Nominal operating pressure: \_\_\_\_\_  
 Actuator arrangement:  Vertical up;  Vertical down;  Horizontal mounting  
 Presence of side load:  Yes;  No; if yes, side load force \_\_\_\_\_ (lbs. or N) at \_\_\_\_\_ (in. or mm) from shaft exit plane.  
 Output force required: \_\_\_\_\_ (lbs. or N); Extend \_\_\_\_\_ (lbs. or N); Retract \_\_\_\_\_ (lbs. or N)  
 Lateral offset:  Yes;  No; if yes, distance from longitudinal axis \_\_\_\_\_ (in. or mm)  
 Shaft speed: \_\_\_\_\_ (in./sec. or m/sec); Cycle rate: \_\_\_\_\_ (cycles/sec.); Dwell time: \_\_\_\_\_ (sec.)  
 Life expectancy: \_\_\_\_\_.

Description of application environment (e.g. dry, wet, specialty chemicals, etc.): \_\_\_\_\_

Application environment temperature, approx. \_\_\_\_\_ (°F or °C); or range of \_\_\_\_\_ to \_\_\_\_\_ (°F or °C)

Special Instructions: (e.g., physical constraints or operating envelope) \_\_\_\_\_

If hollow rod, shaft O.D. \_\_\_\_\_ (in. or mm) ± \_\_\_\_\_. Shaft I.D. \_\_\_\_\_ (in. or mm) ± \_\_\_\_\_.  
 Rod tap(s) \_\_\_\_\_ What is passing through the shaft? \_\_\_\_\_.

If multi-piston, number of pistons: \_\_\_\_\_;  Push only;  Pull only;  Both

If multi-position, number of positions: \_\_\_\_\_ Total stroke \_\_\_\_\_ (in. or mm)  
 1st stroke increment: \_\_\_\_\_, 2nd stroke increment: \_\_\_\_\_, 3rd stroke increment: \_\_\_\_\_ (in. or mm).

If back-to-back, 1st cylinder part number: \_\_\_\_\_, 2nd cylinder part number: \_\_\_\_\_

Presence of impact load:  Yes or  No; if yes, mass of moving object \_\_\_\_\_ (lbs. or kg)  
 Velocity of moving object: \_\_\_\_\_ (in./sec or m/sec); Is object dropped?  Yes;  No If yes, falling height \_\_\_\_\_ (in. or mm);  
 Point of impact from exit plane of shaft \_\_\_\_\_ (in. or mm)  
 If you have specified a Rectangular Cross-Section Actuator, is the impact load on the longer dimension side?  Yes;  No.

Using the sketch below, please identify known moments existing in the 3 planes:

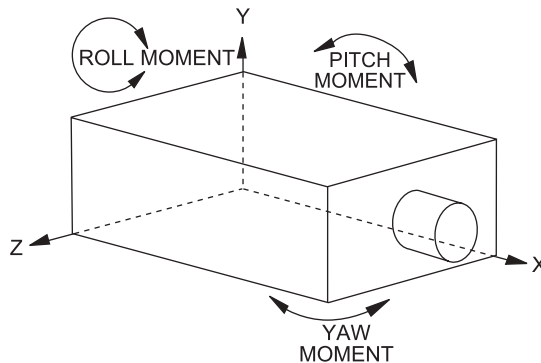

*Feel free to make a copy of this form to be completed and returned with your Request for Quote. You may also access this form on our web site, [www.compactautomation.com](http://www.compactautomation.com), to email your request.*

## Engineering Drawings CD-ROM

To request a **FREE** set of CD-ROMS that contain the detailed engineering drawings of the Compact Automation Universal Series®, please contact us at anyone of the following.

Visit our website at [www.compactautomation.com](http://www.compactautomation.com)

E-mail us at [mkt@compactair.com](mailto:mkt@compactair.com)

*(please be sure to include your name, your company name, full address & telephone number)*

or Call us at 864-674-9521



All products manufactured by Compact Automation Products® are covered under a growing number of US and international patents. Compact®, Husky®, Comtronic®, Tuf-Coat®, Snap-Cap®, Clean-Act® and World Class®, Compact Universal Series® are all registered trademarks of Compact Automation Products, LLC.

Warranty info. (revised 5/00)

All Compact Automation Products® are warranted against defects in workmanship and materials for a period of three years from the date of shipment. Compact Automation's sole obligation and liability under this warranty is expressly limited to the repair, or, at its option, replacement of the defective part or product without cost to the customer. Products under this warranty must be returned prepaid with a "Returned Goods Authorization" number. Repairs performed pursuant to this warranty shall not in anyway extend the warranty period. This warranty does not cover ordinary wear, tear, abuse, misuse, improper storage, and abnormal conditions of temperature, overloading, or improper lubricant. No warranty is made with respect to items altered, damaged in shipment, misapplied, or in contact with contaminants. In no event shall Compact Automation Products® be liable to the customer or any other person for any indirect, special, incidental or consequential losses or damage arising from the use of any Compact Automation Product. THIS WARRANTY IS EXPRESSLY IN LIEU OF AND EXCLUDES ALL OTHER WARRANTIES, EXPRESS OR IMPLIED, INCLUDING THE IMPLIED WARRANTIES OF MERCHANTABILITY AND FITNESS FOR A PARTICULAR PURPOSE.

# Sales and Service in Global Markets

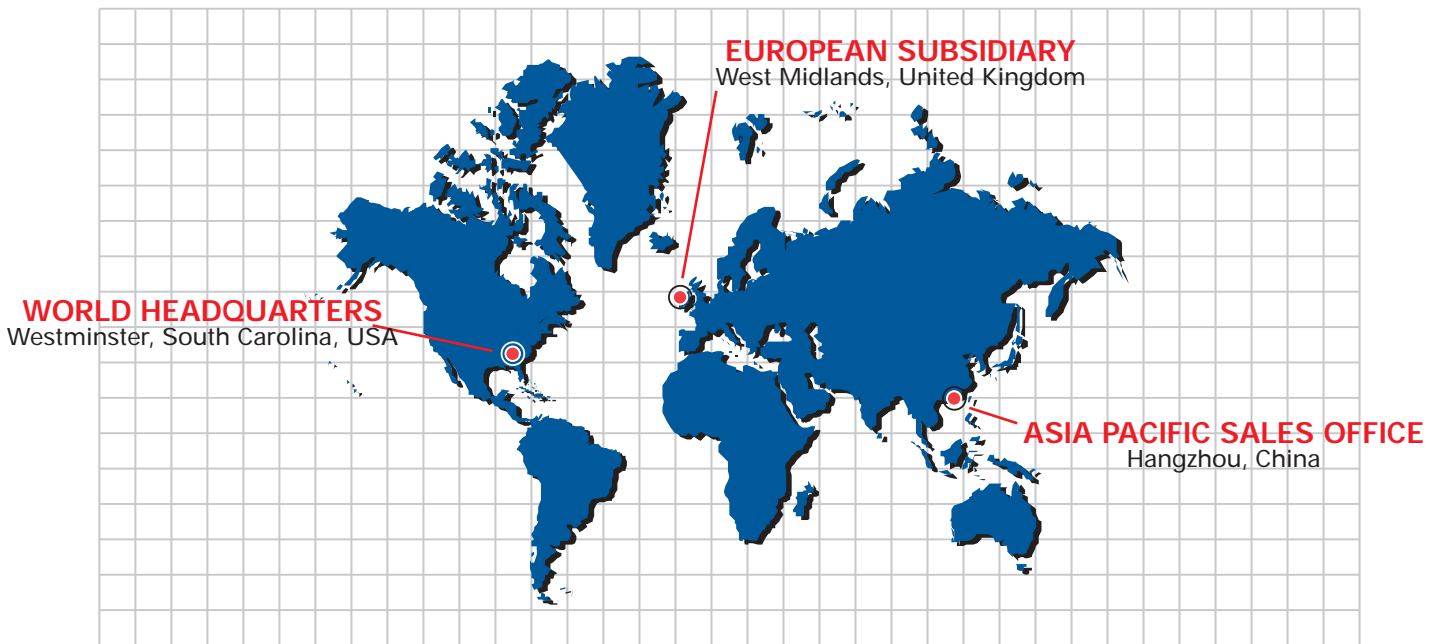

**COMPACT AUTOMATION PRODUCTS® HAS  
DISTRIBUTION IN MORE THAN 40 COUNTRIES  
WORLDWIDE**

For your local authorized distributor, visit our web site at  
[www.compactautomation.com](http://www.compactautomation.com) or call 864-647-9521

**INTERNATIONAL SALES OFFICES**

Design engineers across the globe are selecting Compact Automation Products®. Our proven ability to deliver automation components is leading the industry in selection, innovation, quality and experience through a worldwide service network. Find out more about what Compact® can do for your company by visiting our web site at [www.compactautomation.com](http://www.compactautomation.com).



## **WORLD HEADQUARTERS**

Compact Automation Products®  
105 Commerce Way  
Westminster, SC 29693  
Tel: (864) 647-9521  
Fax: (864) 647-9574  
E-mail: [marketing@compactair.com](mailto:marketing@compactair.com)  
[www.compactautomation.com](http://www.compactautomation.com)

## **EUROPEAN SUBSIDIARY**

Midland-ACS  
Patrick Gregory Road  
Wolverhampton, West Midlands  
WV11 3DZ United Kingdom  
Tel: +44 (0) 1902 305678  
Fax: +44 (0) 1902 305676  
E-mail: [sales@imc-uk.com](mailto:sales@imc-uk.com)

## **ASIA PACIFIC SALES OFFICE**

IMC (Hangzhou) Co., Ltd.  
3rd Floor, No. 1 Building South Area  
No. 98, 19 Street  
Hangzhou Economic & Technological  
Development Zone  
Hangzhou, China 310018  
Tel: +86-571-8671-4399  
Fax: +86-571-8671-4055  
E-mail: [alexliao@imc.hzcnc.net](mailto:alexliao@imc.hzcnc.net)